

Dishwasher Use & Care Manual

comfee'

Dishwasher Use & Care Manual

CS14EFSBK1RCM

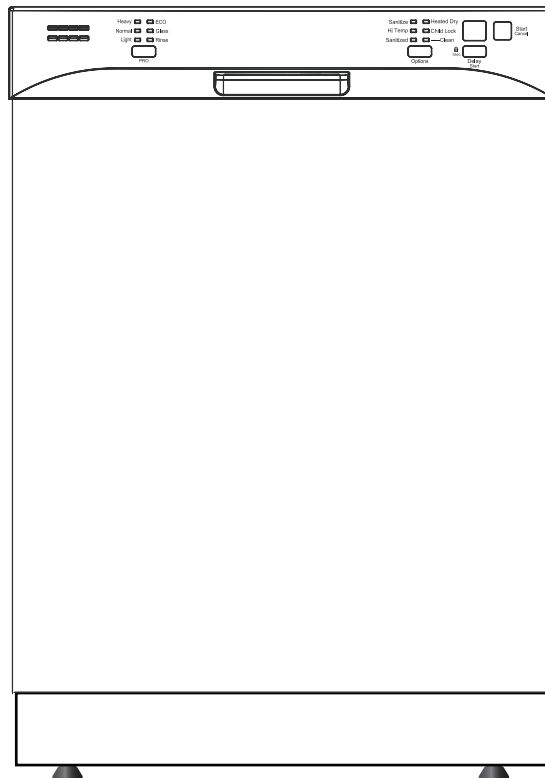

TABLE OF CONTENTS

Important Safety Instructions	2-3	Dishwasher Dispenser and Detergents	11
Dishwasher Features	4	Care and Cleaning	12-13
Operating Instructions	5-7	Solutions to Common Dishwashing Problems.....	14-15
Preparing and Loading Dishes.....	8-10	Warranty.....	16-17

IMPORTANT SAFETY INSTRUCTIONS

WARNING!

When using the dishwasher, follow basic precautions, including the following:

- Water supply temperature should be 120 F or 149 F.
- Dispose of the discarded appliance and packing material properly.
- The dishwasher must be grounded or it can result in a risk of electric shock
- If there is any damage of the dishwasher, please contact to your dealer, do not to attempt to repair or replace any part by yourself .



WARNING!

To reduce the risk of fire or explosion, electric shock, and to prevent damage, personal injury, observe the following:

- Read all instructions before using the dishwasher.
- The manual does not cover every possible condition and situation that may occur .
- Use the dishwasher only for intended function as described in this manual.
- When loading items to be washed:
 - Load sharp items and knives so that they are not likely to damage the door seal and tub.
 - Load sharp items and knives with the handles up to reduce the risk of cut type injury.
 - Do not wash plastic items unless marked “dishwasher safe” or the equivalent, if not marked, check with manufacturer.
 - If the dishwasher drains into a food disposer, make sure disposer is completely empty before running.
 - Do not operate your dishwasher unless all enclosure panels are in the properly place.
 - Do not tamper with or override controls and interlocks
-  Do not touch the **HEATING ELEMENT** during or immediately after use especially if the sanitize option has been selected
- Do not abuse, sit, or stand on door or dishracks of the dishwasher.
- Under certain conditions, hydrogen gas may be produced in a hot water system that has not been used for two weeks or more. **HYDROGEN GAS IS EXPLOSIVE** . If the hot water system has not been used for such a period, before using the dishwasher turn on all hot water faucets and let the water flow from each for several minutes. This will release any accumulated hydrogen gas. As the gas is flammable,do not smoke or use an open flame during this time
- Do not store or use combustible materials, gasoline or other flammable vapors and liquids in the vicinity of this or any other appliance.
- Use only detergents or rinse agents recommended for use in a dishwasher and keep them out of the reach of children.
- Keep young children and infants away from dishwasher when it is operating.

IMPORTANT SAFETY INSTRUCTIONS

- Do not use the dishwasher if it has a damaged power line or plug ,and do not plug the dishwasher into a damage power outlet ,failure to observe these instructions may result in electrical shock .
- Remove the door to the washing compartment when removing an old dishwasher from service or discarding it.
-  Do not touch the **STEAM** on the panel during the washing, especially if sanitize has been selected.
- After unpacking the dishwasher, keep the packaging out of the reach of children.
- Failure to follow these instructions can result in death ,fire ,or electric shock :
Electrically ground the dishwasher.
Connect the ground wire to the green ground connector in the junction box .
Do not use an extension cord.

DISHWASHER FEATURES

Capacity	14 place settings
Dimension	23.89 x 24.5 x 33.74 inches (W x D x H)
Weight	unpacked 78lb (35.5kg)
Power Supply	120volts, 60Hz
Rated power usage	Wash motor 50W Heater 840W
Water Feed Pressure	20-80psi(138-552kPa)



- | | |
|--------------------------|---------------------------------|
| 1 Top Spray Arm | 7 Rinse Aid Dispenser |
| 2 Cup Shelf | 8 Detergent Dispenser |
| 3 Upper Spray Arm | 9 Tub Gasket |
| 4 Lower Spray Arm | 10 Adjustable Upper Rack |
| 5 Bottom Rack | 11 Silverware Basket |
| 6 Heating Element | |

OPERATING INSTRUCTIONS

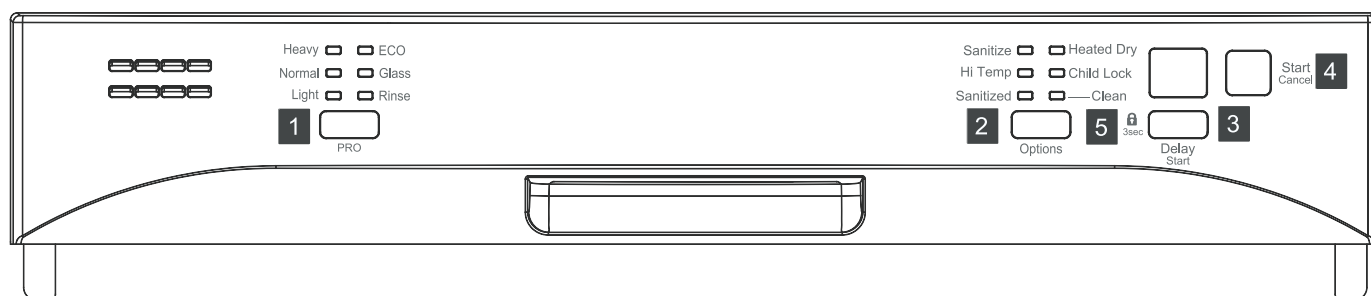

1 PRO

With the dishwasher door close, you can press the PRO button to select the wash cycle. A light on the display will indicate which cycle has been selected.

Wash Cycle Selections

Heavy wash

This cycle is for hard-to-clean, heavily soiled pots, pans and dishes.

Normal wash

This cycle is for regularly soiled dinner dishes or silverware.

Light wash

This cycle is for lightly soiled and pre-rinsed dishes and silverware.

Eco

This cycle is for all items. It can determine the condition of soil on the dishes and initiate the optimal cycle to obtain the best cleaning performance.

Glass

This cycle is for delicate dishes or glasses.

Rinse wash

This cycle is for pre-rinsing dishes or glasses. This is only a rinse that keeps food from drying on your dishes and reduces odor buildup in your dishwasher until you are ready to wash a full load. Do not use detergent.

2 Options

When the wash cycle has been selected, you can choose options by pressing the "Options" button.

Sanitize

To sanitize your dishes and glassware, select the Sanitize option. When selected, the light above the pad will turn on and remain on until end of cycle. The water temperature in the final rinse will be raised. The option is available in Heavy, Normal, Light and Eco.

Hi-Temp Wash

This option can increase the water temperature in the main wash and rinse. This increase in water temperature helps the dishwasher detergent remove food, grease and soil from dishes more effectively. The option is available in Heavy, Normal, Light and Eco.

Heated Dry

This option is available on all cycles except rinse only. The Heated Dry option in combination with rinse aid will enhance drying performance. You can turn off by pressing Heated Dry so that the light goes off during the period of the washing.

OPERATING INSTRUCTIONS

3 Delay Start

To delay the start of a selected cycle, press Delay /Start pad until the desired delay time shows in the LED indicator. It allows you to automatically start your dishwasher for a 1 to 24 hour delay.

To cancel the Delay Start option and begin the cycle before the delay period is over press the Start/Cancel pad.

4 Start/Cancel

Push door firmly closed. The door latches automatically. Select the wash cycle and options desired, the indicator light above the pad will turn on. To start press the Start/Cancel pad once, the light will flash and the wash action begins. To cancel when a cycle is running, press Start/Cancel pad once and the dishwasher will start a 60 second drain and then shut off. At the end of the drain, you can select the desired cycle.

When you want to load more dishes or pause the dishwasher while it is already running, make sure to open the door slowly and carefully as there is a possibility of injury from the hot steam inside the dishwasher. You can add more dishes before the main wash starts. Open the door and check the detergent dispenser. If the main wash section of the detergent dispenser is still closed, you can add items. If the door is opened while the dishwasher is running, a safety mechanism is activated and stops the cycle.

5 Child Lock

You can lock all controls to prevent children from accidentally changing the dishwasher cycle or starting the dishwasher.

Press and hold the Delay Start pad for 3 Seconds the lock graphic light will turn on.

To unlock the control press and hold the Heated Dry pad for 3 seconds, the lock graphic light will turn off.

Indicator light

Sanitize

When "sanitize" option is selected, the temperature of the water will reach a maximum of 70°C (158°F).

Certified residential dishwashers are not intended for licensed food establishments. The sanitize cycle is NSF certified.

Warning: The sanitize option is available with "Heavy" "Normal" "Light" and "ECO" cycle.

Clean

The clean light will turn on at the end of the cycle.

Status Window

01-24

If the Delay Start option is selected, the number of delay start hours shows in the Status Window. If the dishwasher is working and the wash cycle time is more than a hour, number of hours and minutes left shows alternately in the Status Window.

CL

Flashes once the program has been entered and the Start/Cancel key is pressed. It also flashes if the door is opened during a wash cycle. Close the dishwasher door to begin or continue a wash cycle.

MINUTES

Number of minutes left in a cycle (0-59 or 1H-2H). It shows hours and minutes alternately.

OPERATING INSTRUCTIONS

NOTE

The remaining time could suddenly increase or decrease by several minutes. This means the Smart Sensor has checked the soil level and adjusted for the appropriate water fill level.

Program	Description of Cycle	Detergent(g)	Water(L)	Running time (min)	Running time with Hi temp(min)	Running time with Sanitize (min)
Heavy	Pre Wash	0/9.9	22.8	140	150	170
	Pre Wash					
	Wash(48°C)					
	Rinse					
	Rinse					
	Rinse(58°C)					
Normal	Drying	AHAM/CU Test : 0/19.9 DOE Test : 0/9.9 CU Test : 15/15	10.8~23.0	105~135	130	135~165
	Pre Wash					
	Auto(42~48°C)					
	Rinse(50~58°C)					
Light	Drying	0/9.9	11.4~19.3	115~120	125~130	145~150
	Pre Wash					
	Auto(42°C)					
	Rinse(58°C)					
ECO	Drying	0/9.9	19.3	105	115	150
	Pre Wash					
	Pre Wash					
	Wash(40°C)					
	Rinse					
	Rinse(50°C)					
Glass	Drying	0/9.9	19.3	120	/	/
	Pre Wash					
	Pre Wash					
	Wash(48°C)					
	Rinse					
	Rinse(58°C)					
Rinse	0	8.0	20	/	/	

NOTE: The NSF certified is Normal/Auto Cycle with the sanitize option selected.
The CU test is Normal Cycle with the hi temp option selected.

PREPARING AND LOADING DISHES

Dish preparation

Scrape away large pieces of food, bones, pits, toothpicks, etc. The continuous filtered wash system will remove the remaining food particles. Burned-on foods should be loosened before loading. Empty liquids from glasses and cups.

Foods such as mustard, mayonnaise, vinegar, lemon juice and tomato based products may cause discoloration of stainless steel and plastics if allowed to sit for a long period of time. Unless the dishwasher is to be operated at once it is best to rinse off these food soils.

If the dishwasher drains into a food disposer, be sure disposer is completely empty before starting dishwasher.

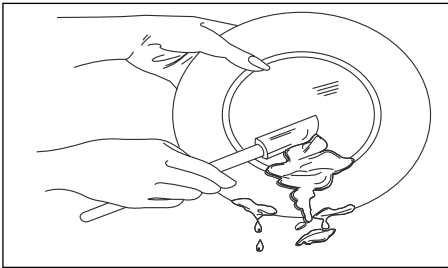

8 place settings standard loading pattern
(For best washing performance, the upper rack should be in the raised position.)



12 place settings standard loading pattern



14 place settings standard loading pattern

Loading the upper rack

The upper rack is designed for cups, glasses, small plates, bowls and plastic items marked "dishwasher safe" etc.

For best results, place the bowls, cups, glasses, sauce pans with soiled surface facing down or toward the center. Tilt slightly for better drainage.



Make sure the loaded dishes do not interfere with the rotation of the middle spray arm, which is located at the bottom of the upper rack. (Check this by rotating the middle spray arm by hand.)

PREPARING AND LOADING DISHES

Loading the Bottom Rack

The bottom rack is designed to load plates, soup bowls, plates, saucers and cookwares. The adjustable rack space will allow you to load maximum 13 inch items.



Large items should be placed along the edge so they do not interfere with the middle spray arm rotation, and make sure they do not prevent the detergent dispenser from opening.

Large items should be turned so that the inside faces downward, and make sure these items do not interfere with the lower spray arm rotation.

The fold-down tines in the bottom rack make it easy to load those extra large and hard-to-fit items. The tines may be left up for normal use or folded down for more flexible loading. Fold down for more space to load large pots or pans.

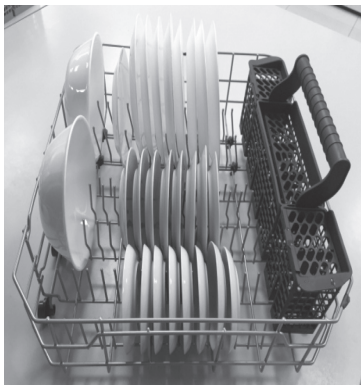

8 place settings standard loading pattern



12 place settings standard loading pattern



14 place settings standard loading pattern

Loading the Silverware Basket

The silverware basket could be divided into three separate modules that can be used in both upper and lower racks

Features and appearance of racks and silverware basket may vary from your model.

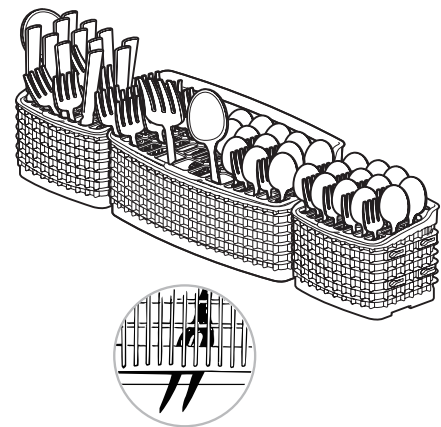

⚠ WARNING!

Do not let any item extend through bottom.



Be sure nothing protrudes through bottom of the basket or rack to block the lower spray arm.

Adding A Dish

To add or remove items after wash cycle starts:

- 1 Open door slightly and wait a few seconds until wash action stops before completely opening.
- 2 Add the item.
- 3 Close door firmly to latch and cycle will automatically resume.

PREPARING AND LOADING DISHES

Adjustable Upper Rack

The upper rack height can be easily adjusted to accommodate loading taller dishes in either rack.

To accommodate taller dishes in the bottom rack, there are 2 positions available:

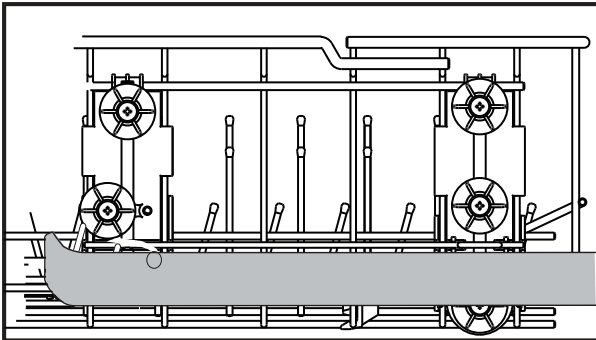

Upper Rack Position

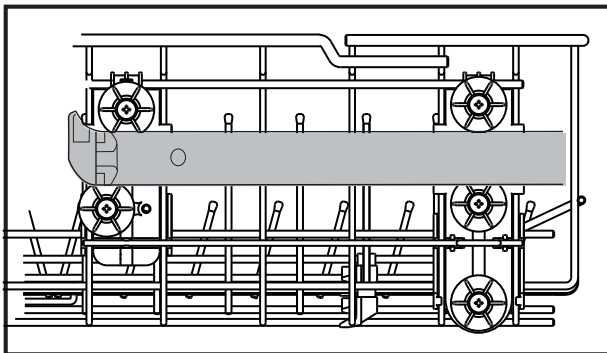

Lower Rack Position



Note:

Height should be adjusted without dishes in the racks.

DISHWASHER DISPENSER & DETERGENTS

Filling the rinse aid dispenser

Rinse aid greatly improves drying and reduces water spots and filming. Rinse agent removes spots and prevents new film build up on your dishes, glasses, flatware, cookware and plastic. Without rinse aid your dishes and dishwasher interior will have excessive moisture. The Heated Dry option will not perform as well without rinse aid. The rinse aid dispenser, located next to the Detergent cup, automatically releases a measured amount of rinse aid during the last rinse.

If spotting and poor drying is a problem, increase the amount of rinse aid dispensed by rotating the dial to a higher number. The dial is located under the dispenser cap.

If the rinse aid is low, the Rinse Aid light is illuminated at the beginning and end of the cycle indicating that it is time to refill.

 **Your dishwasher is designed to use liquid rinse aid. The use of rinse greatly improves drying performance after the final rinse. Do not use a solid or bar-type rinse aid. Under normal conditions, the rinse aid will last approximately one month, try to keep it full, but do not over fill.**

Filling the Dispenser

- 1 Try to keep it full, but do not over fill.
- 2 Turn the dispenser cap to the left and lift it out.
- 3 Add rinse agent until the indicator window looks full.
- 4 Clean up any spilled rinse agent with a damp cloth.
- 5 Replace the dispenser cap.

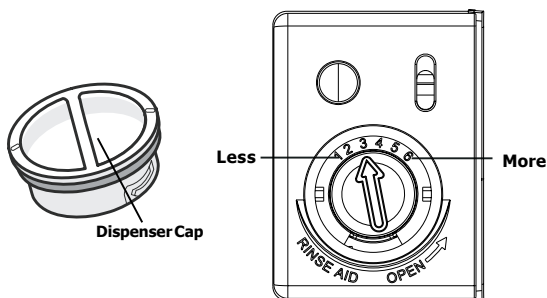

Filling the detergent dispenser

1. Push the dispenser cover latch downwards and open it .

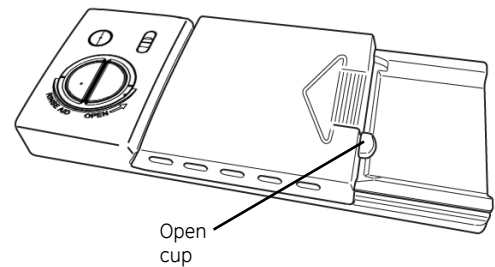

2. Add the detergent to the main wash compartment.

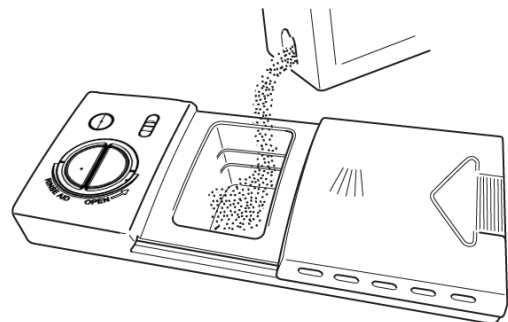

3. After pouring the detergent into the container, close the lid, first pushing (1) and then pressing on it (2) until hear the click.

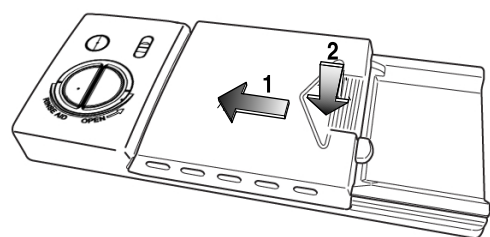

CARE AND CLEANING

Clean the Stainless Steel Inner Door and Tub

The tub is made of Stainless Steel, it will not rust or corrode if the dishwasher should be scratched or dented.

Clean the Cylinder Filter

The Cylinder Filter is designed to collect some big items such as broken glass, bones and pits. The Cylinder Filter needs to be cleaned to maximize wash performance.

Remove the lower rack, rotate the Cylinder Filter as shown, lift it out, empty and clean it by rinsing it under running water and replace.

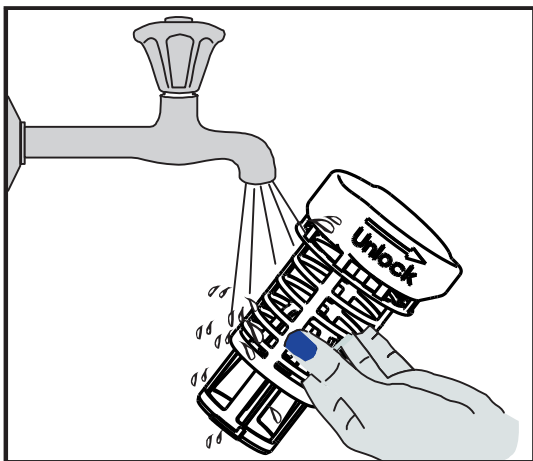
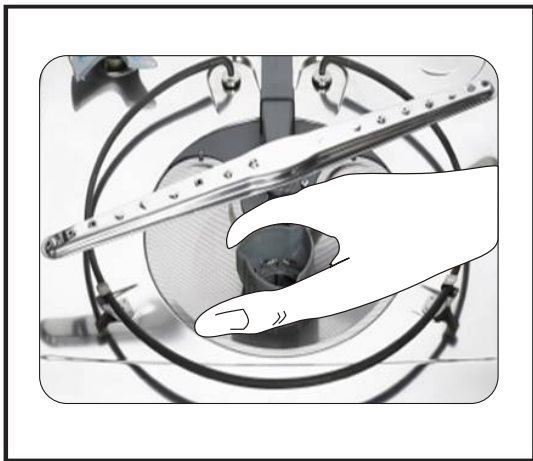

Because hard water chemicals will clog the spray arm jets and bearings, it is necessary to clean the spray arms regularly. Wash the arms in soapy, warm water and use a soft brush to clean the jets. Replace them after rinsing thoroughly.

To remove the **upper or middle spray arm**, unscrew the nut clockwise.

To remove the **lower spray arm**, pull upward.

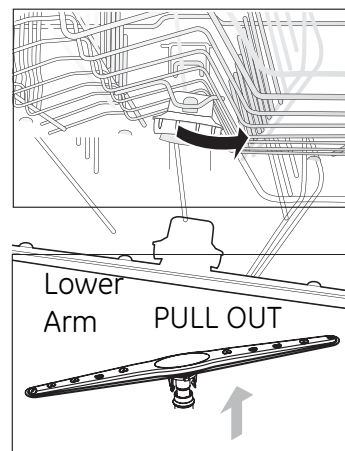

Clean the spots on the steel inner door and tub with a damp nonabrasive cloth.



WARNING

Burn Hazard

Allow heating element to cool before cleaning the interior.

Failure to do so can result in burns.

CARE AND CLEANING

Clean the Fine Filter

Take out the Cylinder Filter and remove the Fine Filter from the dishwasher tub bottom. To remove the Fine Filter you must first remove the bottom spray arm as shown below. Flush the Fine Filter by holding it under running water and replace.

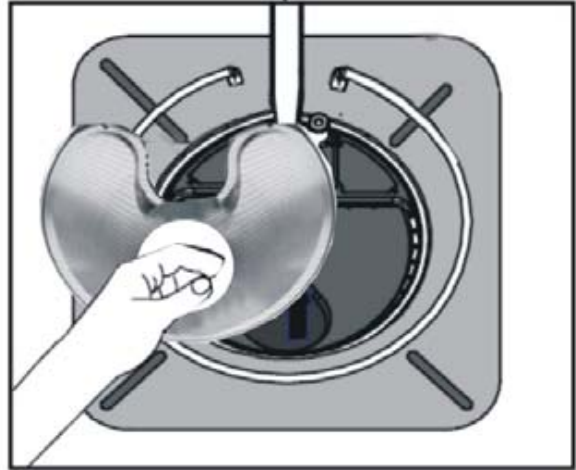
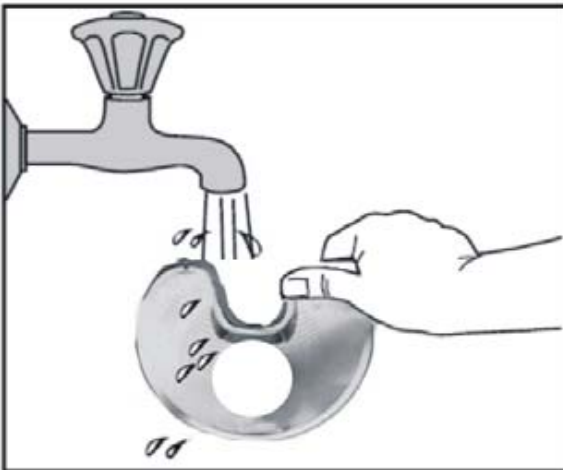
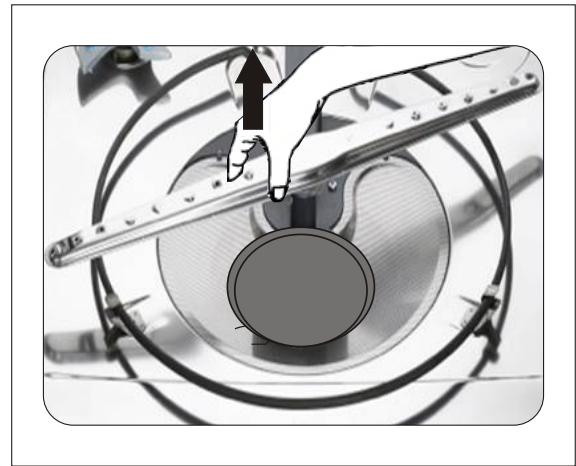
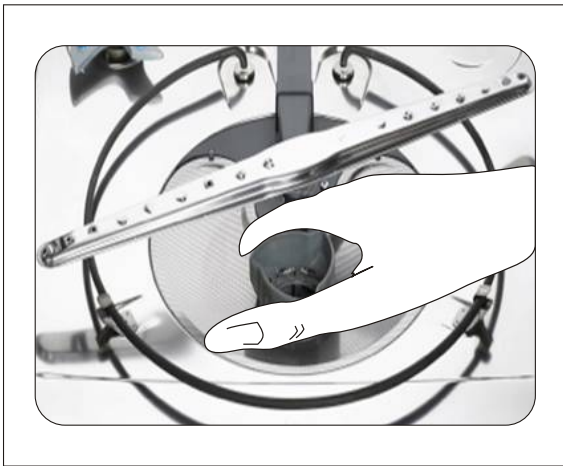

SOLUTIONS TO COMMON DISHWASHING PROBLEMS

Problem	Possible cause	Solution
Dishwasher won't start	Door may not be closed properly	Shut the door completely make sure it is latched
	Power supply or power line is not connected	Check and connect the power supply
	Delay Start option has been selected	Refer to Delay Start section in this manual to rese
	Child Lock activated (selected models)	Deactivate the child lock, refer to child lock section in this manual
Dishwasher beeps at the end of the cycle	It indicates the wash cycle finished, the dishwasher will beep	
Rinse Aid light on	The rinse aid level is low	Add rinse aid
Dishwasher operates too long	The dishwasher is connected to cold water	Check the dishwasher, make sure it connected to the hot water supply
	The cycle time will vary due to the soil	When heavy soil is detected, the , normal, cycle will automatically increase the cycle time
	The sanitize option is selected	When sanitize option is selected, the cycle time will be increase to meet the sanitized temperature request
Dishes are not clean enough	Water pressure is temporarily low	Use you dishwasher when the water pressure is normal
	The inlet water is low	Make sure the dishwasher is connected to the hot water supply Try not use your dishwasher when hot water is being used elsewhere in the house
	Dishes are loaded too close together	Load the dishes again as the manual introduced
	improper use of detergent	Add detergent depending on the water hardness and the cycle you chose. Use fresh deter ent.
	The selected cycle is not suitable for food soil condition	Choose anther cycle for longer washing time
	Spay arms is blocked by some items	Make sure the spay arm is rotating freely
Dishes not drying enough	Rinse Aid dispenser is empty	Fill rinse aid dispenser or increase the amount of rinse aid.
	Improper loading of dishes	Load the dishes again as the manual introduction
	The cycle you chose did not included the drying.	Choose the proper cycle with drying
Spots and filming on dishes	Water hardness is too high	For extremely hard water install a water softener
	Improper loading of dishes	Load the dishes again as the manual indicates
	Old or damp powder rinse aid is used	Use fresh rinse aid
	Rinse Aid dispenser empty	Add rinse aid to the dispenser
Etching	Using too much detergent	Use less detergent if you have soft water
	The inlet water temperature exceeds 150 °F	Lower the inlet water temperature
Detergent left in dispenser cup	Detergent may be too old	Use fresh detergent
	Spray arm is blocked	Load the dishes, making sure the spray arms are not blocked.

SOLUTIONS TO COMMON DISHWASHING PROBLEMS

Problem	Possible cause	Solution
Detergent dispenser will not shut	Improper operation of the detergent cover	Add the detergent and rinse aid as indicated by the manual
Water remains in the dishwasher	Previous cycle has not finished or has been interrupted	Select the proper cycle as indicated by the manual
Dishwasher does not drain properly	Drain is clogged	Check the air gap if you have Make sure the disposer is empty if the dishwasher is connected to the disposer
	Drain hose is kinked	Make sure the drain hose is properly connected to the sink
Suds in the tub	Improper detergent is used	Make sure to use only the automatic dishwasher detergent
Dishwasher leaks	Excessive suds caused by using the improper detergent	Make sure to use only the automatic dishwasher detergent
	Dishwasher is not level	Leveling the dishwasher (see the installation manual)
Black or gray marks on dishes	Aluminum utensils have rubbed against dishes	Chose a higher cycle Make sure the inlet water is no less than 120°F
Stained tub interior	Coffee and tea soil	Using a spot cleaner to remove the soil
	Reddish stain	Some tomato food will cause this, use of the rinse only cycle right after loading this will decrease the staining
Noises	Detergent cup opening \ Drain pump sound	This is normal
	A hard object has entered the wash module. When the object is ground up, the sound should stop.	If the noise persists after a complete cycle, call for service.
Dishwasher won't fill	Water valve is turn off	Check if the water valve is turn on
	Door latch may not be properly seated	Make sure the door is closed

Error Codes

When some malfunctions come on, the appliance will display error codes to warn you:

<i>Codes</i>	<i>Meanings</i>	<i>Possible Causes</i>
E1	Longer inlet time.	Faucets is not opened, or water intake is restricted, or water pressure is too low.
E4	Overflow.	Some element of dishwasher leaks .

▲ WARNING!

- If overflow occurs, turn off the main water supply before calling a service.
- If there is water in the base pan because of an overflow or small leak, the water should be removed before restarting the dishwasher.

MIDEA DISHWASHER LIMITED WARRANTY

ATTACH YOUR RECEIPT HERE. PROOF OF PURCHASE IS REQUIRED TO OBTAIN WARRANTY SERVICE.

Please have the following information available when you call the Customer Service Center:

- Name, address and telephone number
- Model number and serial number
- A clear, detailed description of the problem
- Proof of purchase including dealer or retailer name and address

IF YOU NEED SERVICE:

1. Before contacting us to arrange service, please determine whether your product requires repair. Some questions can be addressed without service. Please take a few minutes to review the Troubleshooting section of the User Manual, or visit <http://us.Midea.com/support>
2. All warranty service is provided exclusively by our authorized Midea Service Providers, in the U.S. and Canada.

Midea Customer Service

In the U.S.A. or Canada, call 1-866-646-4332.

If outside the 50 States of the United States or Canada, contact your authorized Midea dealer to determine whether another warranty applies.

LIFETIME LIMITED WARRANTY

WHAT IS COVERED

FIRST YEAR LIMITED WARRANTY (PARTS AND LABOR)

For one year from the date of purchase, if this major appliance is installed, operated and maintained according to instructions attached to or furnished with the product, Midea America Corporation (hereafter "Midea") will pay for factory specified replacement parts and repair labor to correct defects in materials or workmanship that existed when this major appliance was purchased, or at its sole discretion replace the product. In the event of product replacement, your appliance will be warranted for the remaining term of the original unit's warranty period.

SECOND THROUGH FIFTH YEAR LIMITED WARRANTY PARTS ONLY - LABOR NOT INCLUDED

In the second through fifth years from the date of original purchase, when this major appliance is installed, operated and maintained according to instructions attached to or furnished with the product, Midea will pay for factory parts to correct non-cosmetic defects in materials or workmanship in these parts that prevent an essential function of this major appliance and that existed when this major appliance was purchased. This is a limited 5-year warranty on the parts only and does not include repair labor.

LIFETIME LIMITED WARRANTY (STAINLESS STEEL TUB AND INNER DOOR LINER ONLY)

For the lifetime of the product from the date of original purchase, when this major appliance is installed, operated and maintained according to instructions attached to or furnished with the product, Midea will pay for factory specified parts and repair labor for the following components to correct non-cosmetic defects in materials or workmanship that existed when this major appliance was purchased:

- Stainless steel tub
- Inner door liner

YOUR SOLE AND EXCLUSIVE REMEDY UNDER THIS LIMITED WARRANTY SHALL BE PRODUCT REPAIR OR REPLACEMENT AS PROVIDED HEREIN. Service must be provided by a Midea designated service company. This limited warranty is valid only in the 50 States of the United States or Canada and applies only when the major appliance is used in the country in which it was purchased. This limited warranty is effective from the date of original consumer purchase. Proof of original purchase date is required to obtain service under this limited warranty.

LIFETIME LIMITED WARRANTY

WHAT IS NOT COVERED

1. Commercial, non-residential or multiple-family use, or use inconsistent with published user, operator or installation instructions.
2. In-home Instruction on how to use your product.
3. Service to correct improper product maintenance or installation, installation not in accordance with electrical or plumbing codes or correction of household electrical or plumbing (i.e. house wiring, fuses, plumbing or water inlet hoses).
4. Consumable parts (i.e. light bulbs, batteries, air or water filters, etc.).
5. Defects or damage caused by the use of non-genuine Midea parts or accessories.
6. Damage from accident, misuse, abuse, fire, floods, electrical issues, acts of God or use with products not approved by Midea.
7. Repairs to parts or systems to correct product damage or defects caused by unauthorized service, alteration or modification of the appliance.
8. Cosmetic damage including scratches, dents, chips, and other damage to appliance finishes unless such damage results from defects in materials and workmanship and is reported to Midea within 30 days.
9. Routine maintenance of the product.
10. Discoloration, rust or oxidation of surfaces resulting from caustic or corrosive environments including but not limited to high salt concentrations, high moisture or humidity or exposure to chemicals.
11. Pick-up or delivery. This product is intended for in-home repair.
12. Travel or transportation expenses for service in remote locations where an authorized Midea servicer is not available.
13. Removal or reinstallation of inaccessible appliances or built-in fixtures (i.e. trim, decorative panels, flooring, cabinetry, islands, countertops, drywall, etc.) that interfere with servicing, removal or replacement of the product.
14. Service or parts for appliances with original model/serial numbers removed, altered or not easily identified.

The cost of repair or replacement under these excluded circumstances shall be borne by the customer.

DISCLAIMER OF IMPLIED WARRANTIES

IMPLIED WARRANTIES, INCLUDING ANY IMPLIED WARRANTY OF MERCHANTABILITY OR IMPLIED WARRANTY OF FITNESS FOR A PARTICULAR PURPOSE, ARE LIMITED TO ONE YEAR OR THE SHORTEST PERIOD ALLOWED BY LAW. Some states and provinces do not allow limitations on the duration of implied warranties of merchantability or fitness, so this limitation may not apply to you. This warranty gives you specific legal rights, and you also may have other rights that vary from state to state or province to province.

DISCLAIMER OF REPRESENTATIONS OUTSIDE OF WARRANTY

Midea makes no representations about the quality, durability, or need for service or repair of this major appliance other than the representations contained in this warranty. If you want a longer or more comprehensive warranty than the limited warranty that comes with this major appliance, you should ask Midea or your retailer about buying an extended warranty.

LIMITATION OF REMEDIES; EXCLUSION OF INCIDENTAL AND CONSEQUENTIAL DAMAGES

YOUR SOLE AND EXCLUSIVE REMEDY UNDER THIS LIMITED WARRANTY SHALL BE PRODUCT REPAIR AS PROVIDED HEREIN. MIDEA SHALL NOT BE LIABLE FOR INCIDENTAL OR CONSEQUENTIAL DAMAGES. Some states and provinces do not allow the exclusion or limitation of incidental or consequential damages, so these limitations and exclusions may not apply to you. This warranty gives you specific legal rights, and you also may have other rights that vary from state to state or province to province.
